

● **Features:**

1. Emitted color : Yellow
2. Lens Appearance : Yellow Diffused
3. Low power consumption.
4. High efficiency.
5. Versatile mounting on P.C. Board or panel.
6. Low current requirement.
7. 4.8mm diameter package.
8. This product don't contained restriction substance, compliance ROHS standard.

● **Package dimensions:**

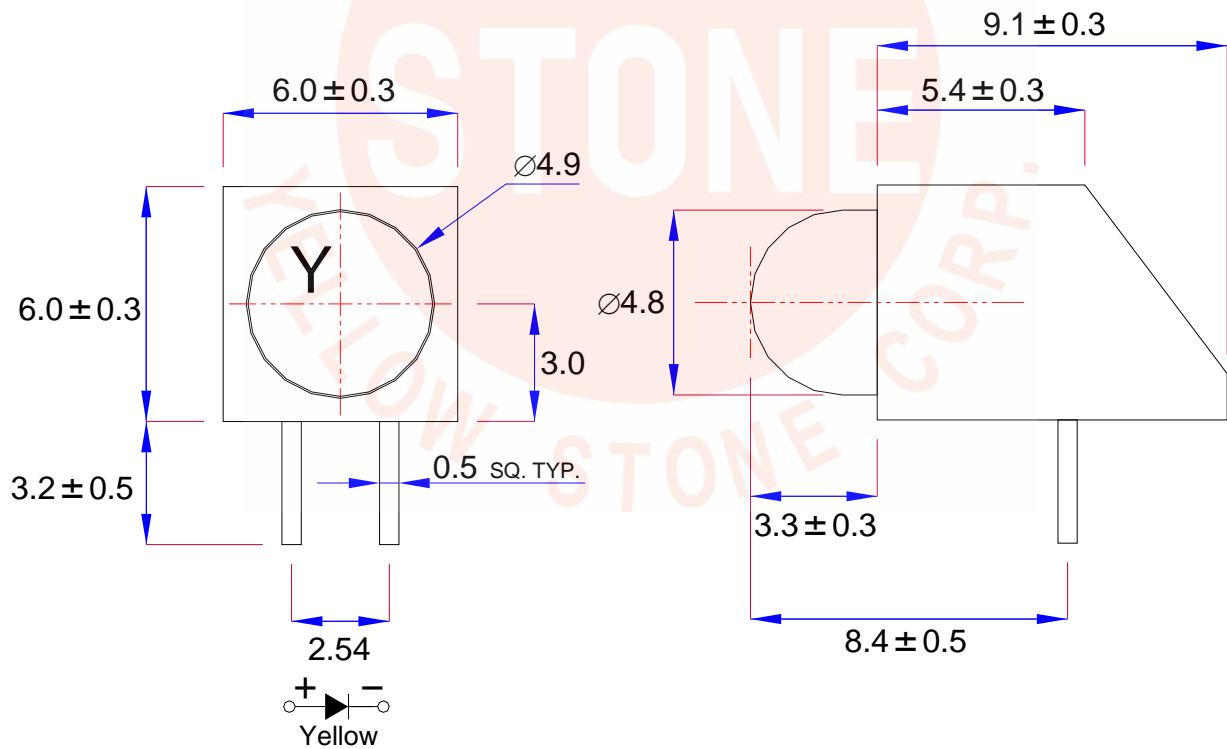

Notes:

1. All dimensions are in millimeters (inches).
2. Tolerance is ± 0.25 mm (0.01") unless otherwise specified.
3. Lead spacing is measured where the leads emerge from the package.
4. Specifications are subject to change without notice.

● **Absolute maximum ratings(Ta=25°C)**

Parameter	Symbol	Rating	Unit
Power Dissipation	Pd	80	mW
Forward Current	I _F	30	mA
Peak Forward Current* ¹	I _{FP}	150	mA
Reverse Voltage	V _R	5	V
Operating Temperature	Topr	-40°C~85°C	
Storage Temperature	Tstg	-40°C~100°C	
Soldering Temperature	Tsol	260°C (for 5 seconds)	
Hand Soldering Temperature	Tsol	350°C (for 3 seconds)	

*¹Condition for I_{FP} is pulse of 1/10 duty and 0.1msec width.

● **Electrical and optical characteristics(Ta=25°C)**

Parameter	Symbol	Condition	Min.	Typ.	Max.	Unit
Forward Voltage	V _F	I _F =10mA	-	2.0	2.5	V
Luminous Intensity	I _v	I _F =10mA	-	30	-	mcd
Reverse Current	I _R	V _R =5V	-	-	100	μA
Peak Wave Length	λ _p	I _F =10mA	-	585	-	nm
Dominant Wave Length	λ _d	I _F =10mA	582	-	595	nm
Spectral Line Half-width	Δλ	I _F =10mA	-	35	-	nm
Viewing Angle	2θ _{1/2}	I _F =10mA	-	40	-	deg

● Typical electro-optical characteristics curves

Fig.1 Relative intensity vs. Wavelength

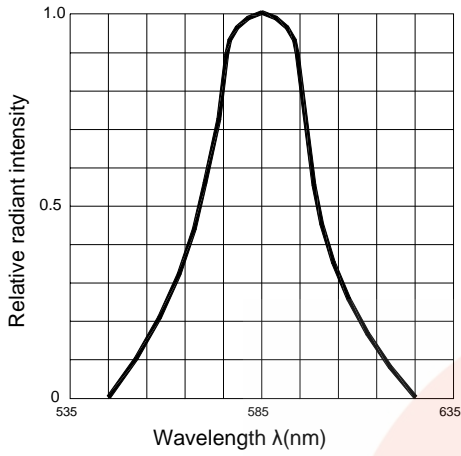

Fig.2 Forward current derating curve vs. Ambient temperature

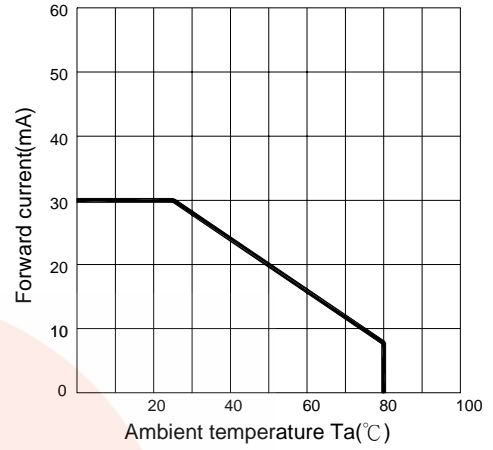

Fig.3 Forward current vs. Forward voltage

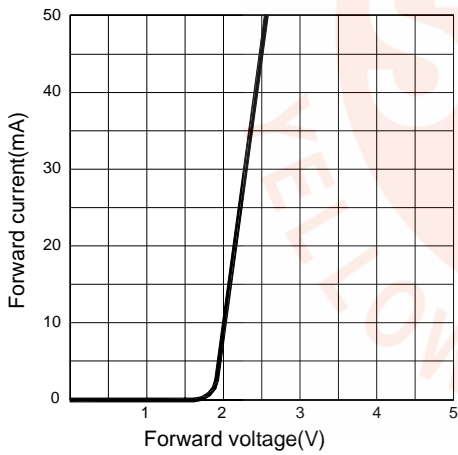

Fig.4 Relative luminous intensity vs. Ambient temperature

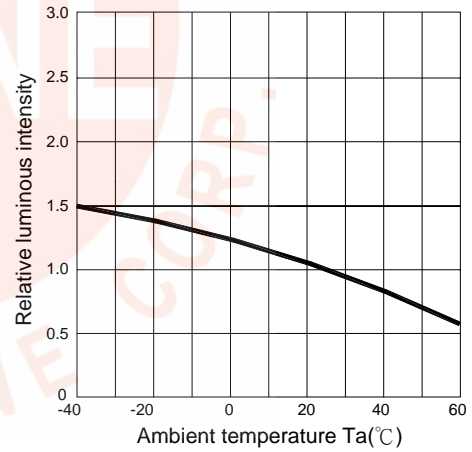

Fig.5 Relative luminous intensity vs. Forward current

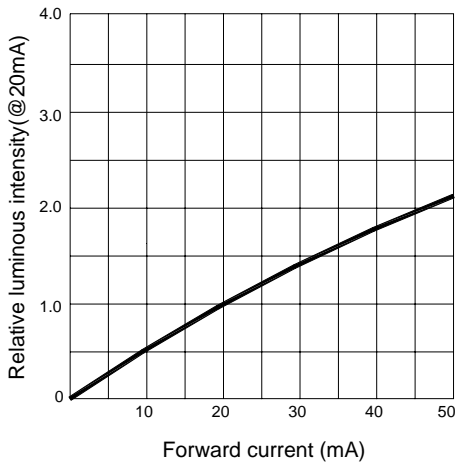
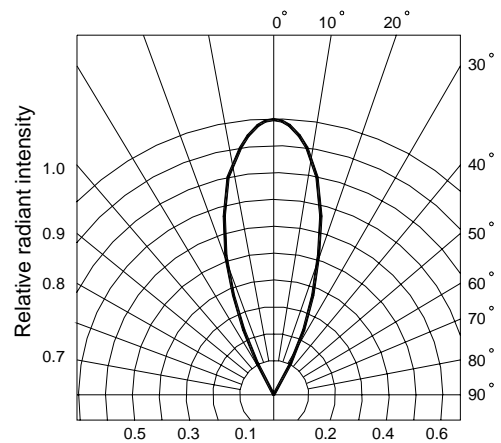
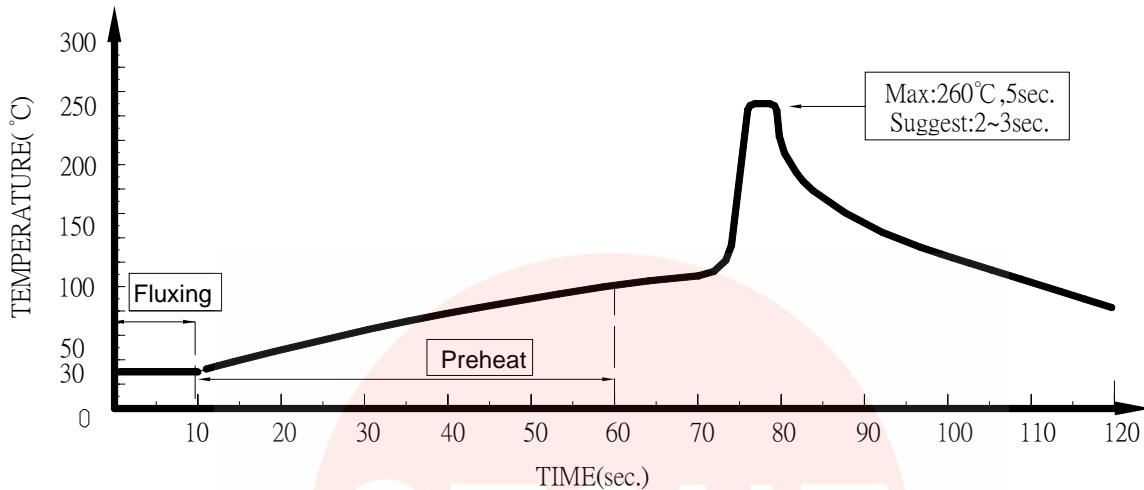

Fig.6 Radiation diagram



● **Dip Soldering**



1. Please avoid any external stress applied to the lead-frames and epoxy while the LEDs are at high temperature, especially during soldering
2. DIP soldering and hand soldering should not be done more than one time.
3. After soldering, avoid the epoxy lens from mechanical shock or vibration until the LEDs are back to room temperature.
4. Avoid rapid cooling during temperature ramp-down process
5. Although the soldering condition is recommended above, soldering at the lowest possible temperature is feasible for the LEDs

● **IRON Soldering**

A : Max : 350°C Within 3 sec. One time only.

B : For 3mm LED without flange, if the LED epoxy lays flat on the PCB, the welding condition is 350°C within 2 seconds, one time only.

